



Acoustic performance with metal

OWAtecta® – metal ceilings

OWA

OWA metal ceilings combine fascinating designs options and interior decoration possibilities with excellent climate and hygienic properties. And their surprisingly good sound insulation is an additional feature which can also be used in acoustically sensitive areas.

Communication and concentration in balance

Employees are an important company asset and the provision of a comfortable, attractive working environment is very important. Acoustically, areas should allow effective communication between co-workers without being intrusive, a balance between communication and concentration. OWA tecta® metal ceilings can be used as a key element in the design of an efficient workspace providing acoustic control, a range of versatile systems and the ability to integrate services within the ceiling plane. As an introduction we explain below some of the acoustic terms you may encounter.

Reverberation time (T)

Reverberation time is the oldest and best known performance criteria in the field of acoustics. It is measured in seconds and is defined as the time taken for a generated sound to decay by 60 dB once the sound source has been stopped.

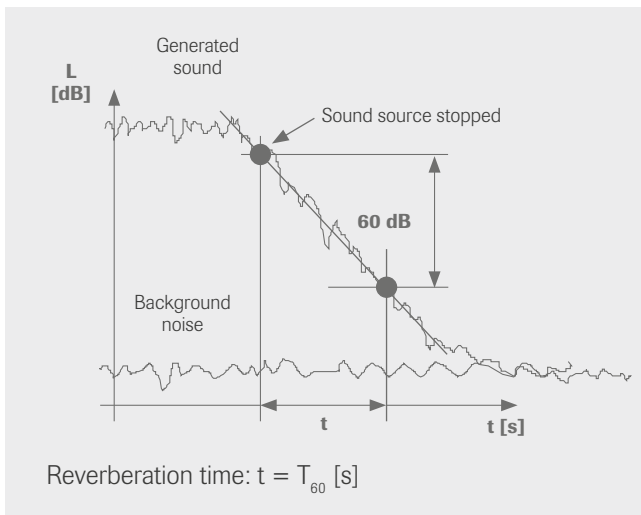

Every room is different

The optimum reverberation time for a room is dependant on its intended use be it office, conference room, classroom, cafeteria or library. Lists of recommended reverberation times for a variety of applications are available from a number of recognised sources such as DIN 18041. Measurement of the rooms RT and any subsequent calculations will be dependant on a number of the room's physical attributes. These include the dimensions and shape of the room, the construction and materials used for the interior surfaces and the type and position of any other materials used in the room.

Sound absorption

Sound absorption measures the amount of sound energy absorbed by a material and is one of the most important performance considerations in the acoustic design of a room. As well as providing the right balance between reflection and absorption, the selection quantity and positioning of sound absorbing materials are key factors in achieving the correct reverberation time for the rooms intended use. Acoustic products in the ceiling are usually totally sufficient, and in special cases, a combined ceiling and wall application is recommended. Most importantly: reflecting and absorbing surfaces must be positioned correctly!

Sound absorption coefficient

The sound absorption coefficient of a material describes its ability to absorb sound and is measured over a number of specific frequencies. The result is expressed as a number between 0 and 1 where 0 is total reflection and 1 is total absorption. If the coefficient is multiplied by 100, it provides the percentage of incident sound that is absorbed.

$\alpha = 0.75$ means $\rightarrow \alpha = 0.75 \times 100\% = 75\%$ sound absorption
(the remaining 25% is sound reflection)

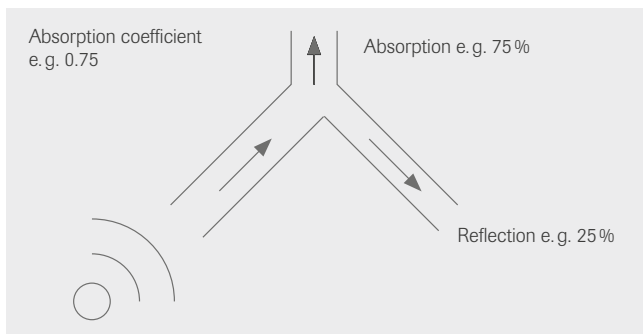

Equivalent sound absorption area "A"

The equivalent sound absorption area (A) is the amount of a material with a sound absorption of $\alpha = 1$ (100 %) that would be needed to provide the required reverberation time. The equation $A = \alpha \times S$ can be used to calculate the equivalent surface area of a material with a sound absorption (" α ") of less than 1.

For example a surface area (S) of 10 m² with a sound absorption of $\alpha = 0.70$ (70 %) provides the equivalent to a surface area (A) of 7 m² using a product with an absorption value of $\alpha = 1$.

Reverberation time and sound absorption

The reverberation time in a room can be calculated by using the formula shown below where:

- reverberation time, T
- volume of the room in m³, V
- total sound absorption of surfaces, A

$$T = 0.163 \cdot \frac{V}{A}$$

$$T = 0.163 \cdot \frac{\text{room volume}}{\text{equivalent sound absorption area}}$$

$$A = \alpha_{\text{Floor}} \cdot \text{surface area}_{\text{Floor}} + \alpha_{\text{Wall}} \cdot \text{surface area}_{\text{Wall}} + \alpha_{\text{Ceiling}} \cdot \text{surface area}_{\text{Ceiling}} + \text{other absorbing surfaces}$$

A... is the total sound absorption of the surfaces within the room.

Sound reduction ΔL through sound absorption

When sound absorbing materials are placed in a room the sound level decreases and results in a more diffuse sound field

$$\alpha L = 10 \cdot \lg \frac{A_2}{A_1} = 10 \cdot \lg \frac{T_1}{T_2} \text{ in [dB]}$$

In this equation A_1 represents the empty room and A_2 the room after the introduction of the absorbing materials.

Note: The full effect of the absorbing materials will not be realised if the subject or measuring equipment is placed in the immediate.

Single figure sound absorption

To enable simple comparison of products the sound absorption performance is also shown as a single figure. However the single figures results do not reflect the full performance and are generally not adequate for an accurate acoustic calculation.

Sound absorption coefficient α_s

Materials are tested for their ability to absorb sound by being placed in a reverberation chamber and tested in accordance with EN ISO 354. The test is carried out over 18 separate frequencies from 100 Hz to 5000 Hz and the results reported individually as a sound absorption coefficient (α_s) between 0.00 (total reflection) and 1.00 (total absorption). Using these results a number of single figures can be produced:

Practical sound absorption coefficient α_p

To ascertain the single value specification α_w , the specified frequency-dependent sound absorption coefficients α_s must be converted into so-called practical sound absorption coefficients α_p for every octave band. To do this, the sound absorption values of three one-third octaves (e.g., for 100 Hz, 125 Hz and 160 Hz) are added, calculated mathematically and rounded up to the nearest 0.05.

$$\alpha_{p,125 \text{ Hz}} = \frac{\alpha_{s,100 \text{ Hz}} + \alpha_{s,125 \text{ Hz}} + \alpha_{s,160 \text{ Hz}}}{3}$$

Using this method, the 18 frequency-dependent sound absorption coefficients α_s are converted to 6 practical sound absorption coefficients α_p .

Weighted sound absorption coefficient α_w

The norm EN ISO 11654 is used to determine the weighted sound absorption coefficient α_w . The weighted sound absorption coefficient α_w is ascertained according to a precisely specified assessment procedure. The reference curve specified in the norm is shifted against the curve from the ascertained α_p values in 0.05 increments until the sum of the values below the reference curve is less than or equal to 0.10. The weighted sound absorption coefficient α_w corresponds to the value of the shifted reference curve at 500 Hz.

The informative annex B of the EN ISO 11654 also contains the classification of the single value specification α_w into the following absorption classes:

Absorption Class	α_w -value [-]
A	0.90; 0.95; 1.00
B	0.80; 0.85
C	0.60; 0.65; 0.70; 0.75
D	0.30; 0.35; 0.40; 0.45; 0.50; 0.55
E	0.15; 0.20; 0.25
Not classified	0.00; 0.05; 0.10

Noise Reduction Coefficient NRC

The American standard ASTM 423 provides similar test criteria to EN ISO 354 and also provides a method for calculating a single figure result called a "Noise Reduction Coefficient" or "NRC". This is calculated using the following equation.

$$\text{NRC} = \frac{\alpha_{250 \text{ Hz}} + \alpha_{500 \text{ Hz}} + \alpha_{1000 \text{ Hz}} + \alpha_{2000 \text{ Hz}}}{4}$$

The result is reported in increments of 0.05

Example:

$$\text{NRC} = \frac{0.39 + 0.58 + 0.73 + 0.61}{4} = 0.58 \rightarrow \text{NRC} = 0.60$$

Sound attenuation

Room to room airborne sound reduction

In many buildings partition walls are not installed to the soffit, but extend only to suspend ceiling level. This makes partitions easier to move and provides a more flexible workspace.

Where this type of construction is used care must be taken to ensure that airborne sound transmission through the common cavity is controlled, especially between sensitive areas.

Diagram:

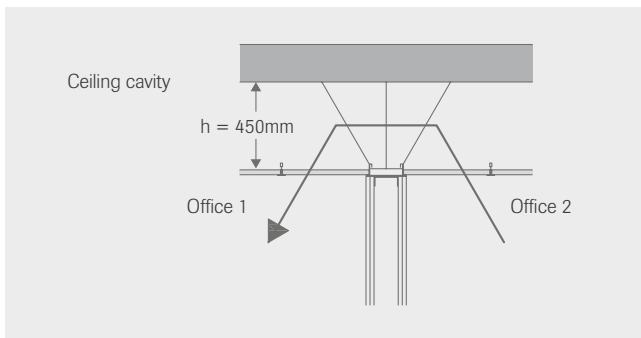

The sound attenuation performance of an OWAtecta® metal ceilings can be enhanced using a number of additional measures:

- combination with OWAcoustic® mineral tiles
- additional insulation layer in the PE film bag
- additional insulation layer with aluminium lamination
- additional insulation layer with a non-perforated sheet metal cover
- installation of a vertical cavity barrier above the walls/partitions

Airborne sound reduction

OWAtecta® metal ceilings can also improve the airborne sound reduction of a structural floor and with the correct selection of system, surface design and additional overlay can significantly reduce noise generated in the ceiling cavity.

Noise from the ceiling void

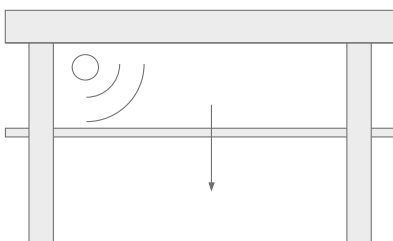

Design	Suspension depth	Practical sound absorption figure α_p						NRC value	α_w value	SRA value	Absorber class	Page
		125	250	500	1000	2000	4000					
OWAtecta Rg0701	E200	0.35	0.60	0.70	0.60	0.50	0.45	0.55	0.55	0.55	D	8
OWAtecta Rd1522	E200	0.25	0.65	0.85	0.65	0.70	0.70	0.70	0.70	0.70	C	8
OWAtecta Rd2508	E200	0.30	0.65	0.80	0.70	0.70	0.70	0.70	0.75	0.70	C	9
OWAtecta Rg2516	E200	0.35	0.70	0.85	0.75	0.75	0.75	0.75	0.80	0.75	B	9
OWAtecta Qg8043	E200	0.25	0.60	0.80	0.60	0.70	0.75	0.65	0.70	0.70	C	10

Sketch of test assembly



OWAtecta® Rg0701

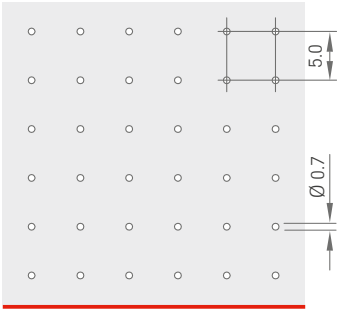

Freq. [Hz]	Suspension depth E50 α_p	Suspension depth E100 α_p	Suspension depth E200 α_p	Suspension depth E400 α_p
125	0.15	0.20	0.35	0.45
250	0.40	0.55	0.60	0.55
500	0.65	0.75	0.70	0.55
1000	0.70	0.70	0.60	0.55
2000	0.60	0.50	0.50	0.55
4000	0.45	0.45	0.45	0.40
NRC	0.60	0.65	0.55	0.55
α_w	0.60	0.55	0.55	0.55
SRA	0.60	0.60	0.55	0.50

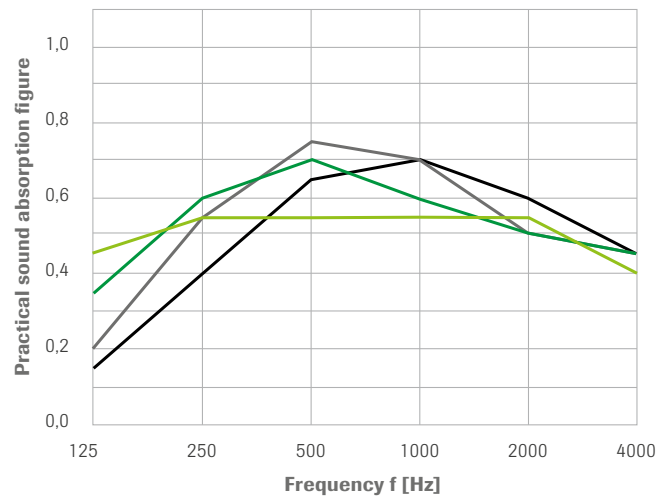

OWAtecta® Rd1522

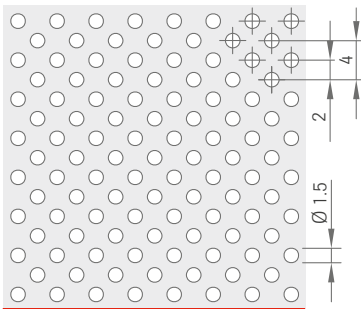

Freq. [Hz]	Suspension depth E50 α_p	Suspension depth E100 α_p	Suspension depth E200 α_p	Suspension depth E400 α_p
125	0.05	0.10	0.30	0.40
250	0.15	0.30	0.65	0.75
500	0.35	0.70	0.85	0.60
1000	0.70	0.85	0.65	0.70
2000	0.85	0.65	0.70	0.70
4000	0.70	0.70	0.70	0.75
NRC	0.50	0.60	0.70	0.70
α_w	0.40	0.60	0.70	0.70
SRA	0.65	0.70	0.70	0.65

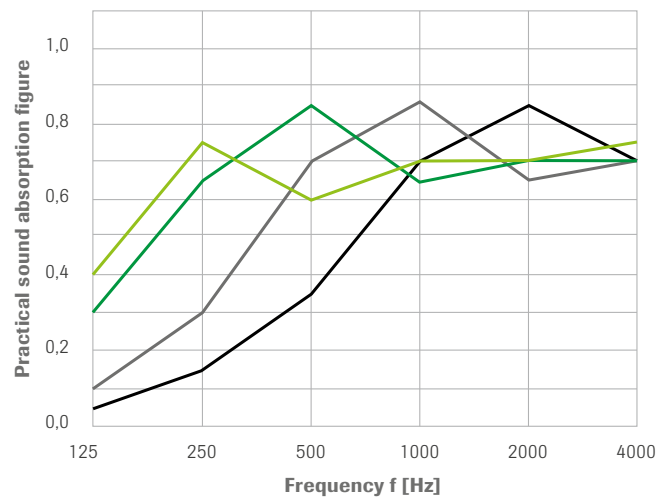

OWAtecta® Rd2508

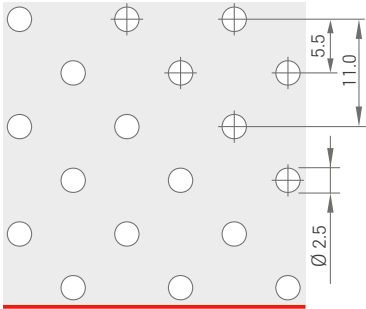

Freq. [Hz]	Suspension depth E50 α_p	Suspension depth E100 α_p	Suspension depth E200 α_p	Suspension depth E400 α_p
125	0.10	0.15	0.30	0.45
250	0.30	0.50	0.65	0.70
500	0.55	0.75	0.80	0.65
1000	0.80	0.85	0.70	0.70
2000	0.80	0.70	0.70	0.70
4000	0.65	0.65	0.70	0.65
NRC	0.65	0.70	0.70	0.65
α_w	0.55	0.75	0.75	0.70
SRA	0.70	0.75	0.70	0.65

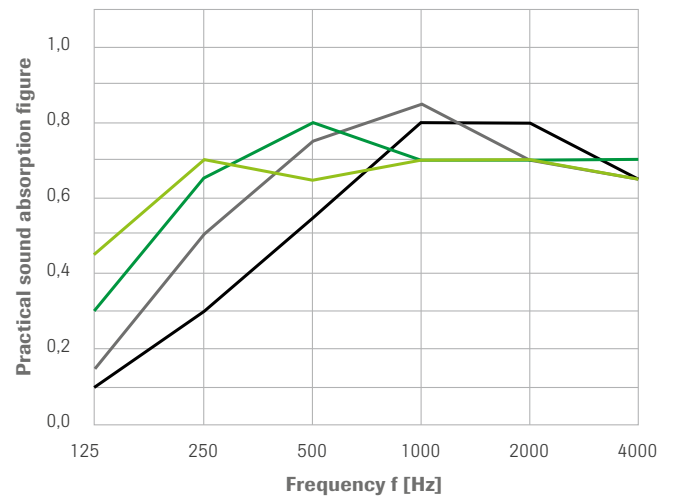

OWAtecta® Rg2516

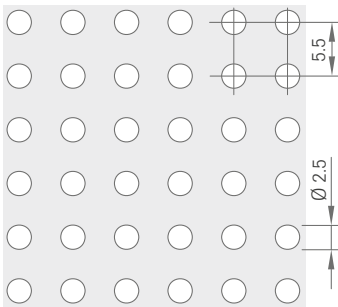

Freq. [Hz]	Suspension depth E50 α_p	Suspension depth E100 α_p	Suspension depth E200 α_p	Suspension depth E400 α_p
125	0.10	0.20	0.35	0.40
250	0.30	0.50	0.70	0.70
500	0.55	0.80	0.85	0.70
1000	0.80	0.90	0.75	0.75
2000	0.90	0.75	0.75	0.80
4000	0.75	0.70	0.75	0.75
NRC	0.65	0.75	0.75	0.75
α_w	0.55	0.75	0.80	0.75
SRA	0.75	0.80	0.75	0.75

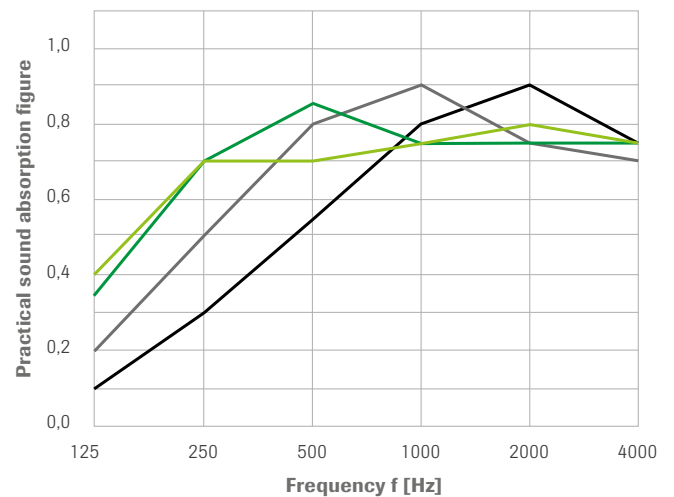

OWAtecta® Qg8043

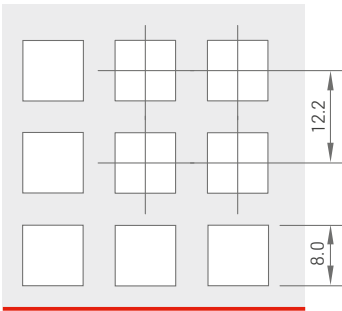

Freq. [Hz]	Suspension depth E200 α_p	Suspension depth E400 α_p
125	0.25	0.45
250	0.60	0.75
500	0.80	0.55
1000	0.60	0.65
2000	0.70	0.70
4000	0.75	0.70
NRC	0.65	0.65
α_w	0.70	0.65
SRA	0.70	0.65

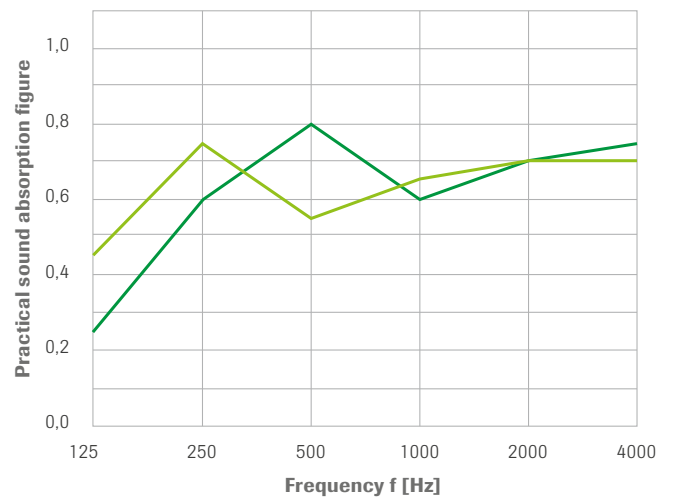

Sound absorption

This brochure provides an overview of the sound absorption values of OWAtecta® standard perforations.

If you would like more information or have any other question on acoustics our OWAconsult® specialists would be happy to help.

Thomas Plötzner

tel +49 93 73.2 01-1 61

OWAconsult®

tel +49 93 73.2 01-2 22

info@owaconsult.de

www.owaconsult.de

Please contact the OWAtecta® Team with any questions concerning metal ceilings and their application possibilities. Take advantage of our expertise based on 60 years of ceiling research. We provide consultation and support and are happy to be of assistance in the realisation of your projects.

Patrick Henn

tel +49 93 73.2 01-2 21



Odenwald Faserplattenwerk GmbH

Dr.-F.-A.-Freundt-Straße 3 | 63916 Amorbach | Germany

tel +49 93 73.2 01-0 | info@owa.de

www.owa-ceilings.com